

S 永發泗汀檯

STEAM TABLE - Gas



WSTG Series / Item# _____



WSTG - A

Standard Features:

- All welded stainless steel construction.
- Standing pilot for instant lighting.
- Standard models available with up to 10' wide.
- Safety gas valve for safety.
- One year limited warranty.

Options:

- AGA certified, NSF Sanitation Classified, MEA listed.
- All models may have rectangular or circular shaped opening on the top, the opening dia. may vary, depending on the size of inset.
- Custom models are available to meet your needs.
- Natural or propane gas.



WSTG - C

Gas requirements:

- Manifold Pressure:
- 5.0" W.C. Natural Gas
- 10.0" W.C. Propane Gas
- Manifold Size: 3/4"

The manufacturer reserves the rights to modify materials and specifications without notice.

S 永發泗汀檯 TEAM TABLE - Gas



WSTG Series / Item# _____



Model#	Rectangular #	Circle #	Plate #	Burners #	BTU	Length	Safty Gas Valve	Ship. Wt.
WSTG-A Series								
WSTG-2A	N/A	4	1	1	?	24"	1	?
WSTA-3A	N/A	6	1	1	?	36"	1	?
WSTG-4A	N/A	8	2	1	?	48"	1	?
WSTG-5A	N/A	10	2	2	?	60"	1	?
WSTG-6A	N/A	12	2	2	?	72-1/2"	1	?
WSTG-6A	N/A	12	2	2	?	72-1/2"	1	?
WSTG-B Series								
WSTG-3B	2	N/A	N/A	1	?	30"	1	?
WSTG-4B	3	N/A	N/A	1	?	43"	1	?
WSTG-5B	4	N/A	N/A	2	?	56"	1	?
WSTG-6B	5	N/A	N/A	2	?	69"	1	?
WSTG-7B	6	N/A	N/A	2	?	82"	1	?
WSTG-8B	7	N/A	N/A	3	?	97"	2	?
WSTG-9B	8	N/A	N/A	4	?	110"	2	?
WSTG-C Series								
WSTG-3C	1	4	1	1	?	39"	1	?
WSTG-4C	1	6	1	1	?	50"	1	?
WSTG-5C	1	8	2	2	?	60"	1	?
WSTG-6C	1	10	2	2	?	72"	1	?
WSTG-7C	4	6	1	2-3	?	90"	2	?
WSTG-8C	3	10	2	3	?	97"	2	?
WSTG-D Series								
WSTG-4D	N/A	4	1	1	?	48"	1	?
WSTG-5D	N/A	6	1	1	?	60"	1	?

The manufacturer reserves the rights to modify materials and specifications without notice.

S 永發泗汀檯

TEAM TABLE - Gas



WSTG Series / Item# _____



20-1/4" 水盤寬度適合於標準湯板

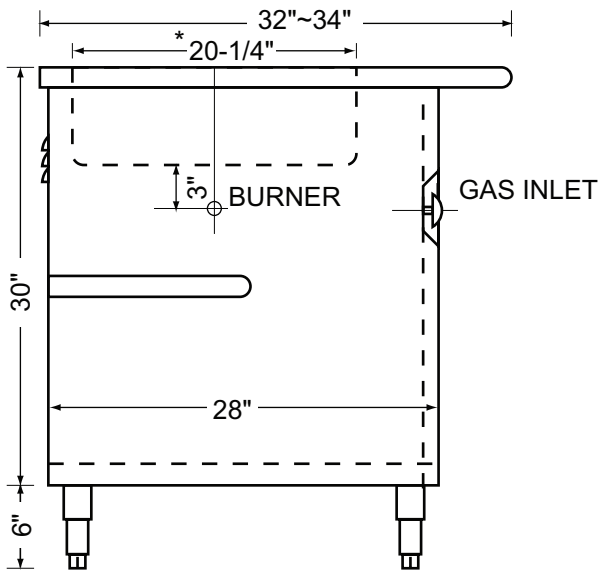

- GAS 泗汀爐三圍必須設置百也窗
- A型適合於標準湯板
- B型適合於標準盤或壹格盤湯板
- C型二者通用水盤採用20" 寬，湯板定做(屬於特定設計)
- 客戶可根據自身條件選擇或發熱絲選擇GAS管道或罐裝GAS，選擇數碼控制開關或機械式手動開關

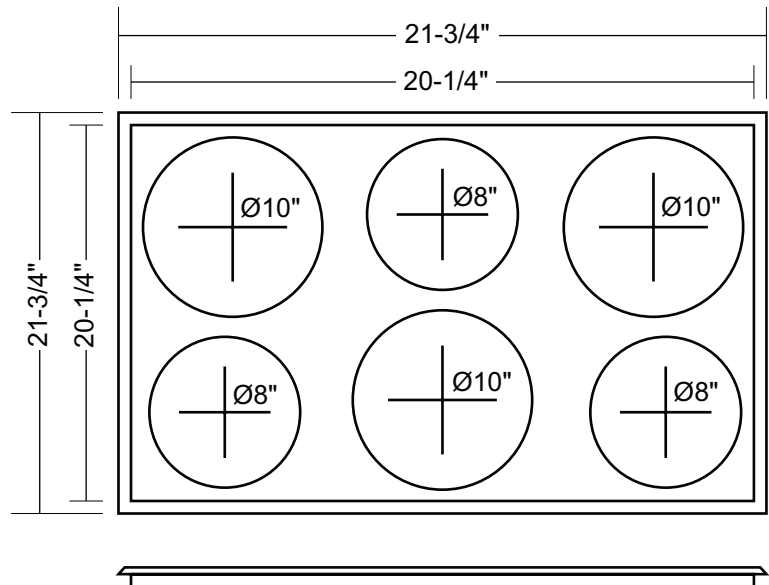
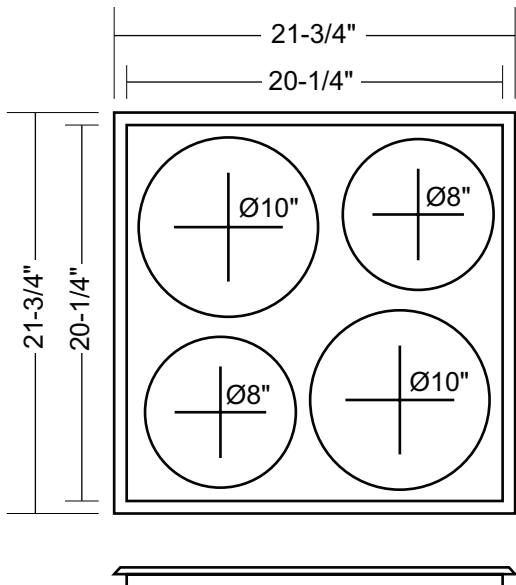

The manufacturer reserves the rights to modify materials and specifications without notice.

S 永發泗汀檯

STEAM TABLE - Gas



WSTG Series / Item# _____



267-90E

WSTG-A

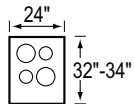

WSTG-2A

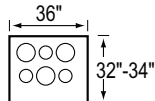

WSTG-3A

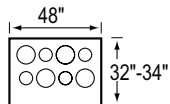

WSTG-4A

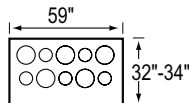

WSTG-5A

WSTG-B

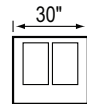

WSTG-3B

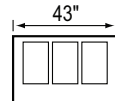

WSTG-4B

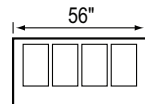

WSTG-5B

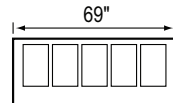

WSTG-6B

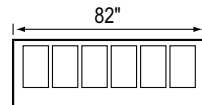

WSTG-7B

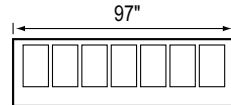

WSTG-8B

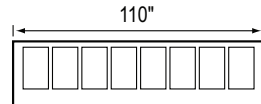

WSTG-9B

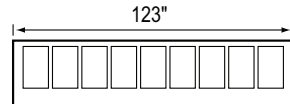

WSTG-10B

WSTG-C

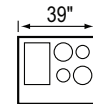

WSTG-3C

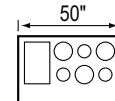

WSTG-4C

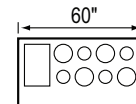

WSTG-5C

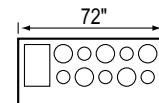

WSTG-6C

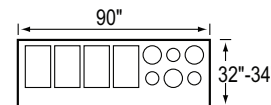

WSTG-7C

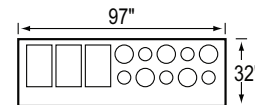

WSTG-8C

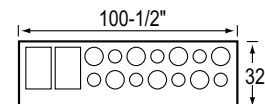

WSTG-9C

WSTG-D

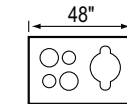

WSTG-4D

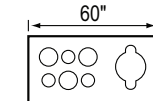

WSTG-5D

The manufacturer reserves the rights to modify materials and specifications without notice.

S 永發泗汀檯

STEAM TABLE - Electric



WSTE Series / Item# _____



WSTE - A

Standard Features:

- All welded stainless steel construction.
- Standing pilot for instant lighting.
- Standard models available with up to 10' wide.
- Safety gas valve for safety.
- One year limited warranty.

Options:

- AGA certified, NSF Sanitation Classified, MEA listed.
- All models may have rectangular or circular shaped opening on the top, the opening dia. may vary, depending on the size of inset.
- Custom models are available to meet your needs.
- Natural or propane gas.



WSTE - D

The manufacturer reserves the rights to modify materials and specifications without notice.

S 永發泗汀檯 **TEAM TABLE - Electric**



WSTE Series / Item# _____



Model#	Rectangular #	Circle #	Plate #	Watts (KW)	Amps/60/1ph		Amps/60/1ph		Ship. Wt.
					208v	240v	208v	240v	
WST-A Series									
WST-2A	N/A	4	1	1.5	-	-	-	-	?
WST-3A	N/A	6	1	1.5	-	-	-	-	?
WST-4A	N/A	8	2	3.0	14.4	12.5	14.4	12.5	?
WST-5A	N/A	10	2	3.0	14.4	12.5	14.4	12.5	?
WST-6A	N/A	12	2	3.0	14.4	12.5	14.4	12.5	?
WST-6A	N/A	12	2	3.0	14.4	12.5	14.4	12.5	?
WST-B Series									
WST-3B	2	N/A	N/A	3.0	14.4	12.5	14.4	12.5	?
WST-4B	3	N/A	N/A	5.0	24	20	24	20	?
WST-5B	4	N/A	N/A	6.0	28.9	25	28.9	25	?
WST-6B	5	N/A	N/A	7.0	33.65	29.17	33.65	29.17	?
WST-7B	6	N/A	N/A	7.0	33.65	29.17	33.65	29.17	?
WST-8B	7	N/A	N/A	5.0+5.0	48.1	41.7	48.1	41.7	?
WST-9B	8	N/A	N/A	6.0+6.0	57.7	50.0	57.7	50.0	?
WST-C Series									
WST-3C	1	4	1	1.5	-	-	-	-	?
WST-4C	1	6	1	1.5	-	-	-	-	?
WST-5C	1	8	2	3.0	14.4	12.5	14.4	12.5	?
WST-6C	1	10	2	3.0	14.4	12.5	14.4	12.5	?
WST-7C	4	6	1	6.0	28.9	25	28.9	25	?
WST-8C	3	10	2	5.0	24	20	24	20	?
WST-D Series									
WST-4D	N/A	4	1	5.0	24	20	24	20	?
WST-5D	N/A	6	1	5.0	24	20	24	20	?

The manufacturer reserves the rights to modify materials and specifications without notice.

S 永發泗汀檯 TEAM TABLE - Electric



WSTE Series / Item# _____



* 20" 水盤寬度適合於標準盤

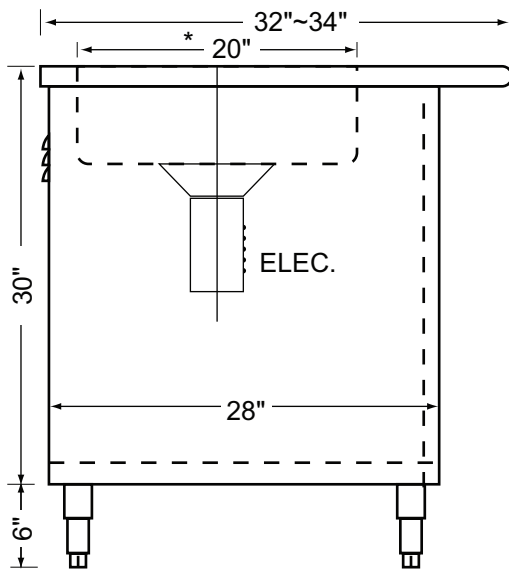

- A型適合於標準湯板
- B型適合於標準盤或壹格盤湯板
- C型二者通用水盤採用20" 寬，湯板定做(屬於特定設計)
- 客戶可根據自身條件選擇或發熱絲選擇GAS管道或罐裝GAS, 選擇數碼控制開關或機械式手動開關

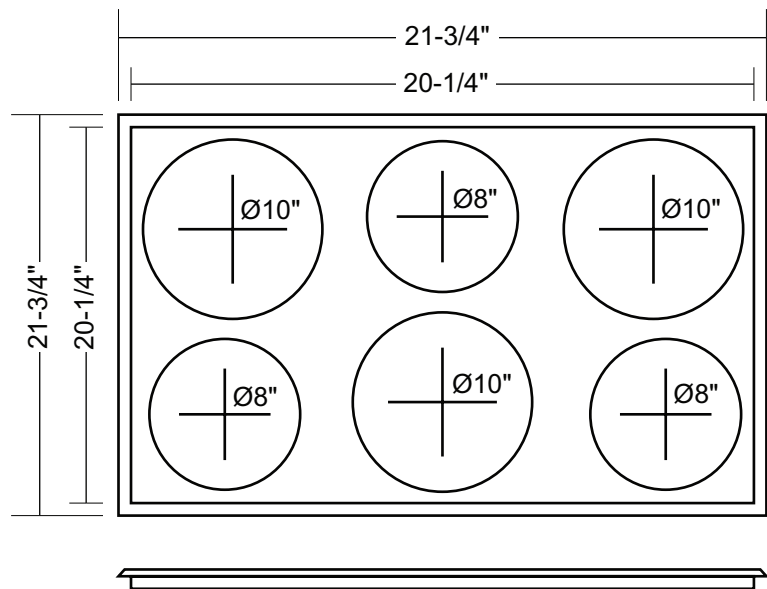
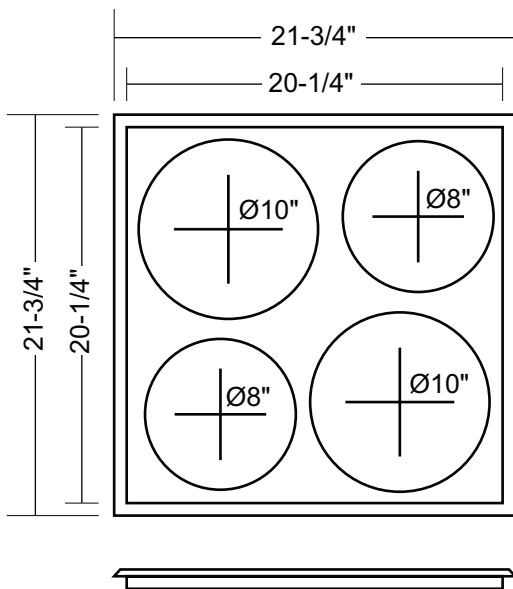

The manufacturer reserves the rights to modify materials and specifications without notice.

S 永發泗汀檯 TEAM TABLE - Electric



WSTE Series / Item# _____



WSTE-A

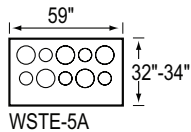
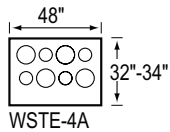
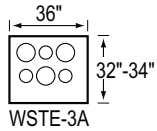
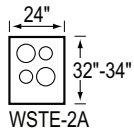

WSTE-B

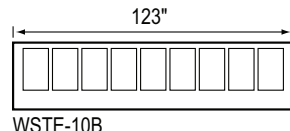
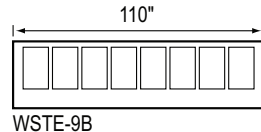
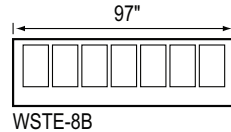
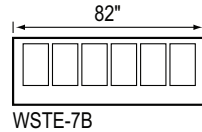
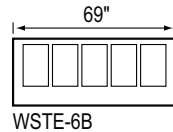
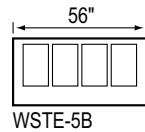
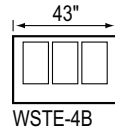
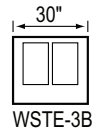

WSTE-C

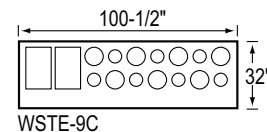
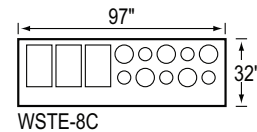
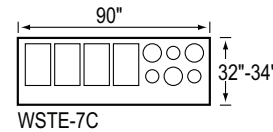
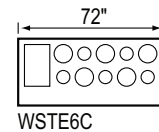
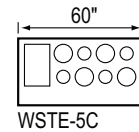
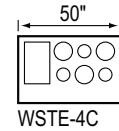
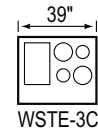

WSTE-D

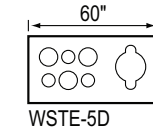
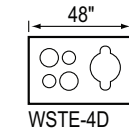

The manufacturer reserves the rights to modify materials and specifications without notice.